





Modulating room thermostat

Opentherm Modulating room thermostat



**Installation and
Service Manual**

Contents

1	Preface	2
	1.1 General	2
2	Location	3
	2.1 Position of the regulator	3
	2.2 Installation and connection	3
3	Commissioning	5
	3.1 Fitted control unit	5
	3.1.1 Control	5
	3.1.2 Default setting	5
4	Settings	6
	4.1 Changing the settings	6
	4.1.1 Modifying the temperature	6
	4.1.2 Menu structure	6
	4.2 User settings	7
	4.2.1 User menu 	7
	4.3 Fitter menu	7
	4.3.1 Information menu 	7
	4.3.2 Installer menu 	8
	4.3.3 Counter menu 	8
	4.3.4 Service menu SERVICE	8
5	Messages	10
	5.1 Error messages	10
6	Technical specifications	11
	6.1 Technical specifications	11

1 Preface

1.1 General

The Opentherm Modulating room thermostat is a simple modulating room thermostat based on the OpenTherm SmartPower protocol. Certain De Dietrich boiler types offer other functions in addition to the room thermostat function. These functions include setting parameters. See the installation and service manual for the boiler.



This installation and service manual describes all the functions of the Opentherm Modulating room thermostat.



WARNING

OpenTherm SmartPower is required for the backlight. In boilers without OpenTherm, the Opentherm Modulating room thermostat is functional but without backlight.



2 Location

2.1 Position of the regulator

The controller works using room control. This means that the inside temperature is used to control the central heating.

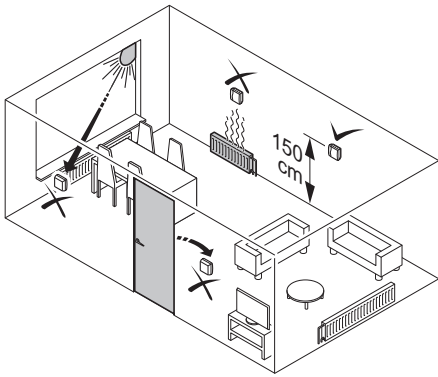

R000083-B

- ▶ Install the regulator in the reference room (generally the living room).
- ▶ Do not locate the controller too close to heat sources (fireplace, radiator, lamp, candles, direct sunlight etc), or in places where it may be draughty.

2.2 Installation and connection

Before you can connect the controller, you must first:

1. Adjust the boiler so that it can be connected to a OpenTherm controller. See the installation and service manual for the boiler.
2. Shut down the boiler.
3. Open the housing by pulling the front and the base plate apart.

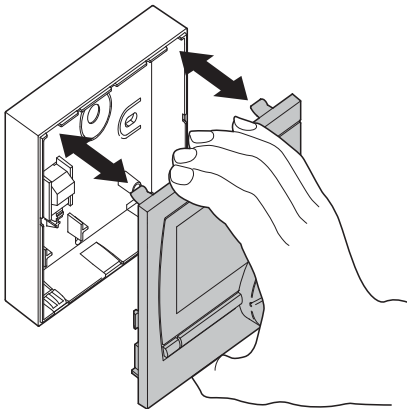

R000078-A

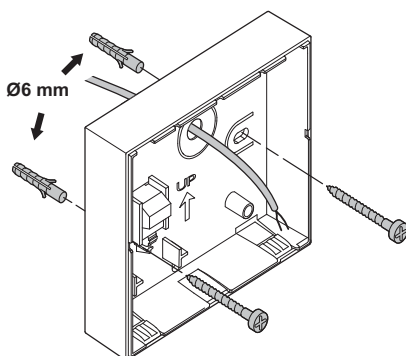

R000058-D

4. Attach the base plate to the wall using the screws and plugs supplied. Ensure that the OpenTherm connecting wires for the boiler are poking through the hole in the base plate.

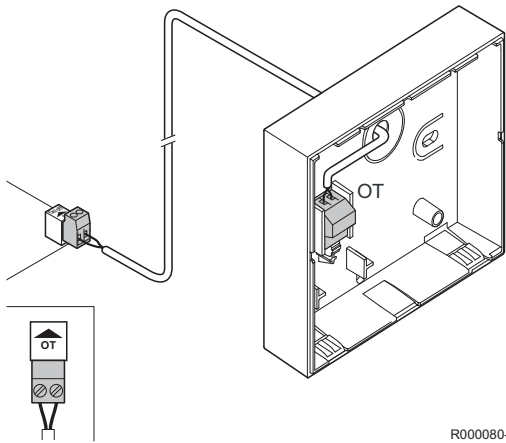

5. Connect the controller to the OpenTherm connection of the boiler, and to the **OT** connection of the controller. OpenTherm is not sensitive to polarity. The wires are interchangeable.

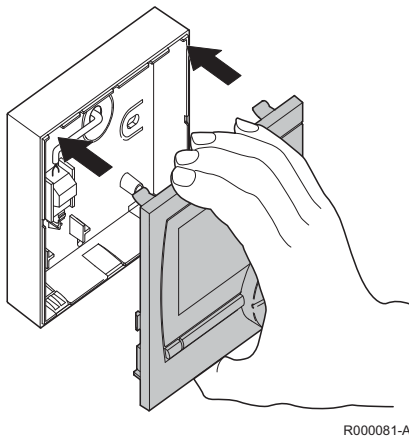

6. Place the front panel back in the housing.

3 Commissioning

3.1 Fitted control unit

3.1.1. Control

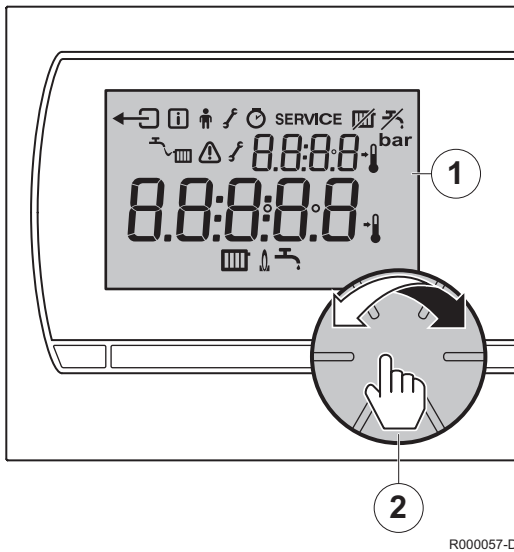

R000057-D

- 1 Display
- 2 Rotary and push button for setting the controller

The controller is menu-controlled, which means it is very simple to operate. The controller has just 1 button.



- ▶ The button is both a rotary button and a push button.
- ▶ Turn it to scroll through menus or change values.
- ▶ Press it to confirm choices (Such as menu selections).

■ Meaning of the symbols on the display

Symbol	Meaning	Symbol	Meaning
	ECO mode on		Back
	Water pressure too low		Information menu
	Defect		User menu
	Boiler service required		Installer menu
	Current temperature		Counter menu
	Set temperature	SERVICE	Service menu
	Central heating function on		Burner on
	Domestic hot water function on		

3.1.2. Default setting

The controller works using room control (Central heating is controlled on the basis of the inside temperature).



- This is the default setting:
- ▶ Set temperature **15°C**
 - ▶ **ECO AUTO**
 - ▶ The most recent set temperature is saved

4 Settings

4.1 Changing the settings

4.1.1. Modifying the temperature

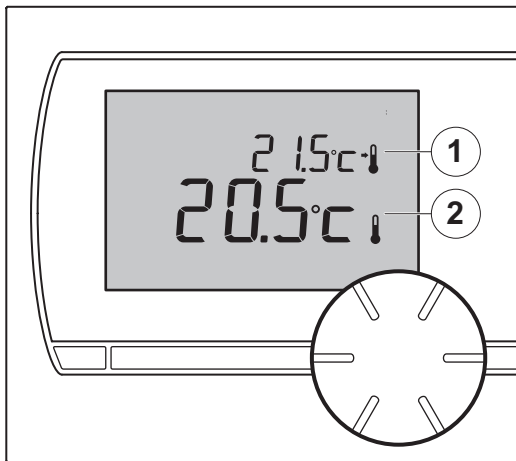

R000077-A

- 1 Set temperature
- 2 Measured temperature

- ▶ Turn the button to set the ambient temperature.
- ▶ Press the button to confirm.

4.1.2. Menu structure

To access the menu, proceed as follows:

- ▶ Press the rotary and push button for at least 3 sec.
- ▶ Turn the button until you reach the required menu.
- ▶ Press the button to confirm.
- ▶ Amend the selected menu item.
- ▶ Press the button to confirm.
- ▶ Exit the menu by pressing



WARNING



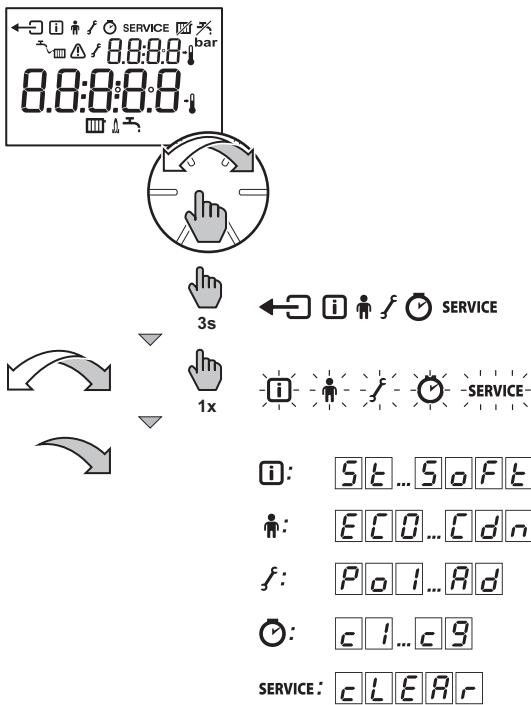





















The values to be read may differ depending on the connected heating unit. See the installation and service manual for the boiler.



R000064-C

4.2 User settings









4.2.1. User menu

Code	Meaning	Information	Settings	Factory setting
	DHW standby function	The ECO mode turns off the DHW standby function. In combi boilers the waiting time increases. Calorifiers are no longer kept warm.	 = Automatic position  = Start  = Stop	
	Tap water temperature	Setting the required tap water temperature, for calorifiers with a temperature programme.	30 to 75 °C	60°C 
	Maximum central heating water temperature	Setting the required central heating water temperature.	0 to 100 °C	90°C 
	Heating rate	Setting how fast or slow the controller responds.	 = Fastest  = Faster  = Normal  = Slower  = Slowest  = Extra Slow	
	Cooling rate	Indicate how fast or slow the house cools down. A well insulated house will cool down slower.	 = Fastest  = Faster  = Normal  = Slower  = Slowest	

4.3 Fitter menu

4.3.1. Information menu

This menu provides access to various kinds of information about the boiler and any connected accessories.

Symbol	Meaning
	State
	Sub-status
	Current inlet temperature (°C)
	Current return temperature (°C)
	Current tank temperature (°C) (Only if an DHW sensor is connected)
	Current outside temperature (°C) (Only if an outside temperature sensor is connected)
	Current solar tank temperature (°C) (Only with the sensor connected)
	Current ionization current
	Current fan speed omw/min

Symbol	Meaning
P _r	Current water pressure (Only boilers with a water pressure sensor)
P _o	Current heat output of boiler
S _o F _t	Control system software version

4.3.2. Installer menu

In this menu, the installer can—depending on the boiler—adjust some of the functions and access information.

- i** The following is applicable to all installer settings:
- ▶ The values to be read may differ depending on the connected heating unit.
 - ▶ The meaning of the various codes may differ for different boilers.
 - ▶ After selection of a parameter, it takes 1 s before the parameter is retrieved.

Settings > Installer menu  0012

Settings	
P001 to P015	Consult the boiler manual when changing the boiler parameters. If an invalid value is entered, F21L appears on the screen.
dFdU	Revert to the factory settings. See the installation and service manual for the boiler.
Rd	Carrying out an auto-detect. See the installation and service manual for the boiler.

4.3.3. Counter menu

The history of various boiler functions can be checked in this menu.

Settings > Counter menu 

Code	Meaning
c 1	Unsuccessful starts
c 2	Number of times with no or low flame
c 3	Number of successful starts
c 4	Number of central heating pump starts
c 5	Number of DHW pump starts
c 6	Number of DHW burner starts
c 7	Total operating hours
c 8	Number of central heating pump operating hours
c 9	Number of DHW pump operating hours

4.3.4. Service menu SERVICE

Boiler service messages can be reset here.

Settings > Service menu **SERVICE**



WARNING

Reset the service message after the boiler service has been carried out. This can be the active message or the next message.



- ▶ If `- - - -` is displayed in the service menu, the boiler will not show a service code.
- ▶ The `CLERR` message indicates that a (pre-) service reset is possible. The message `CLERR A`, `b` or `C` indicates that service message `A`, `b` or `C` can be reset.
- ▶ The boiler determines which service message can be reset.

Code	Meaning
<code>CLERR</code>	Service reset



Only a qualified engineer may carry out the following operations.

When the `CLERR` message is displayed, you can choose to either retain the service message or reset it. If no action is taken, the service message will remain. To reset the service message, proceed as follows:

1. Press the rotary and push button.
2. Turn the button to `CL:YES`.
3. Press the button to confirm.
4. The controller will then return to the `- - - -` screen.



Multiple resets are not possible.

Operations to be carried out		
SERVICE <code>CLERR</code> <code>A</code> <code>b</code> <code>C</code>	SERVICE <code>A</code> <code>CL:NO</code>	SERVICE <code>A</code> <code>CL:YES</code>

5 Messages

5.1 Error messages



R000125-A

If an error is present, a fault code and a fault indication will appear on the display.

Error codes	Fault indication	Probable causes	Solution
F203	⚠	Faulty connection to boiler.	Check the boiler's connection to the controller.
F214	⚠	Incorrect room temperature reading.	Room temperature reading is incorrect. The temperature sensor may be defective if the room temperature is between -5°C and 65°C. Contact your installer.
F215	⚠	Controller failure.	Contact your installer
F217	⚠ +	Water pressure too low.	Top up the water in the central heating system. See the installation and service manual for the boiler.
no SP	⚠	Your boiler may not support the OpenTherm SmartPower.	OpenTherm SmartPower is required for the backlight. In boilers without OpenTherm SmartPower, the Opentherm Modulating room thermostat is functional but without backlight. To clear the message, press the button.

6 Technical specifications

6.1 Technical specifications

Dimensions	
	80 x 90 x 32,5 (l x b x h) mm
Power supply	
OpenTherm regulator	OpenTherm
Electrical connection	
OpenTherm regulator	OpenTherm communication. Low-voltage connection
Ambient conditions	
Storage conditions	Temperature: -25°C +60°C
	Relative humidity 5% - 90% no condensation
Operating conditions	0°C - 60°C
Temperature	
Room temperature	Measurement range: -5°C +65°C
	Maximum temperature deviation at 20°C: 0,3°C
Temperature control area	5 - 35°C
Adjustment	Modulating temperature control
	The control can be optimised
Room control	Overshoot: Maximum 1°C after pre-heating
	Temperature variation: Less than 0,25°C
Adjustment strategies	Adjustment of the room temperature
Features of the controller	
Backlight	Colour: blue
Control precision	Temperature: 0,5°C
Control	Rotary and push button
Mounting	Directly on the wall using screws. Or built-in junction box as per standards
Quality marks and compliance with standards	<ul style="list-style-type: none"> ▶ EMC: 2004/108/EC, 55014 ▶ Emission EN61000-6-3 ▶ Immunity EN61000-6-2 ▶ Drop test IEC 68-2-32 ▶ RoHs Compliant ▶ OpenTherm V3.0 Smartpower
Protection classification	IP20

**DE DIETRICH THERMIQUE S.A.S**

www.dedietrich-thermique.fr
 Direction des Ventes France
 57, rue de la Gare
 F- 67580 MERTZWILLER
 ☎ +33 (0)3 88 80 27 00
 📠 +33 (0)3 88 80 27 99

**DE DIETRICH REMEHA GmbH**

www.remeha.de
 Rheiner Strasse 151
 D- 48282 EMSDETTEN
 ☎ +49 (0)25 72 / 9161-0
 📠 +49 (0)25 72 / 9161-102
 info@remeha.de

**DE DIETRICH**

www.dedietrich-otoplenie.ru
 129164, Россия, г. Москва
 Зубарев переулок, д. 15/1
 Бизнес-центр «Чайка Плаза»,
 офис 309
 ☎ +7 (495) 221-31-51
 dedietrich@nnt.ru

**VAN MARCKE**

www.vanmarcke.be
 Weggevoerdenlaan 5
 B- 8500 KORTRIJK
 ☎ +32 (0)56/23 75 11

**NEUBERG S.A.**

www.dedietrich-heating.com
 39 rue Jacques Stas
 L- 2010 LUXEMBOURG
 ☎ +352 (0)2 401 401

**DE DIETRICH THERMIQUE Iberia S.L.U.**

www.dedietrich-calefaccion.es
 C/Salvador Espriu, 11
 08908 L'HOSPITALET de LLOBREGAT
 ☎ +34 935 475 850
 info@dedietrich-calefaccion.es

**DE DIETRICH SERVICE**

www.dedietrich-heiztechnik.com
 ☎ Freecall 0800 / 201608

**WALTER MEIER (Klima Schweiz) AG**

www.waltermeier.com
 Bahnstrasse 24
 CH-8603 SCHWERZENBACH
 +41 (0) 44 806 44 24
 Serviceline +41 (0)8 00 846 846
 ☎ +41 (0) 44 806 44 25
 ch.klima@waltermeier.com

WALTER MEIER (Climat Suisse) SA

www.waltermeier.com
 Z.I. de la Veyre B, St-Légier
 CH-1800 VEVEY 1
 ☎ +41 (0) 21 943 02 22
 Serviceline +41 (0)8 00 846 846
 ☎ +41 (0) 21 943 02 33
 ch.climat@waltermeier.com

**DUEDI S.r.l.**

www.duediclima.it
 Distributore Ufficiale Esclusivo
 De Dietrich-Thermique Italia
 Via Passatore, 12 - 12010
 San Defendente di Cervasca
 CUNEO
 ☎ +39 0171 857170
 📠 +39 0171 687875
 info@duediclima.it

**DE DIETRICH**

www.dedietrich-heating.com
 Room 512, Tower A, Kelun Building
 12A Guanghua Rd, Chaoyang District
 C-100020 BEIJING
 ☎ +86 (0)106.581.4017
 +86 (0)106.581.4018
 +86 (0)106.581.7056
 ☎ +86 (0)106.581.4019
 contactBJ@dedietrich.com.cn

**BDR Thermea (Czech republic) s.r.o**

www.dedietrich.cz
 Jeseniova 2770/56
 130 00 Praha 3
 ☎ +420 271 001 627
 info@dedietrich.cz

AD001-AI



OpenTherm®

© Copyright

All technical and technological information contained in these technical instructions, as well as any drawings and technical descriptions supplied, remain our property and shall not be multiplied without our prior consent in writing.

31032014



7616664

De Dietrich

DE DIETRICH THERMIQUE

57, rue de la Gare F- 67580 MERTZWILLER - BP 30